

AOYUE[®]

Replacement Air Nozzles

SGL SERIES

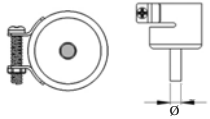

MODEL #	NOZZLE SIZE Ø
1124	2.4mm
1130	4.4mm
1194	6mm
1195	8mm
1196	7mm
1197	9mm
1198	12mm

1325 Air Nozzle

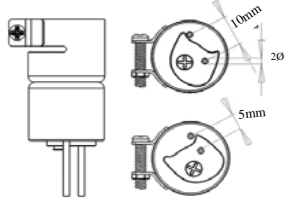

1142 Air Nozzle

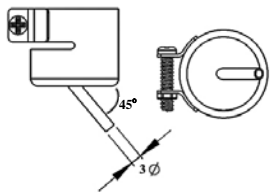

SIL SERIES

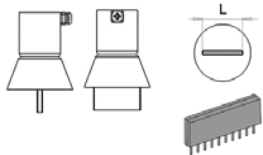

MODEL #	IC SIZE	L (mm)
1191	SIP25L	26
1192	SIP50L	52.5

BGA SERIES

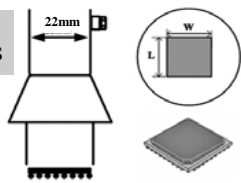

MODEL #	IC SIZE	L (mm)	W (mm)
1010	9×9mm	10	10
1313	12×12mm	13	13
1616	15×15mm	16	16
1919	18×18mm	19	19
2828N	27×27mm	28	28
3030N	29×29mm	30	30
3232W	31×31mm	32	32
3636W	36×36mm	36	36
3939W	38×38mm	39	39
4141W	40×40mm	41	41
4343W	42×42mm	43	43
4545W	44×44mm	45	45

QFP SERIES

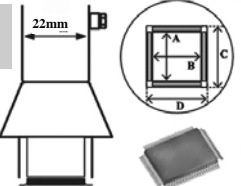

MODEL #	IC SIZE	A (mm)	B (mm)	C (mm)	D (mm)
1125	10×10mm	9	9	16	16
1126	14×14mm	14	14	21	21
1127	17.5×17.5mm	18	18	25	25
1128	14×20mm	20	14	21	27
1129	28×28mm	28	28	35	35
1215	42.5×42.5mm	41	41	48	48
1261	20×20mm	19	19	26	26
1262	12×12mm	11	11	18	18
1263	28×40mm	38	28	35	45
1264	40×40mm	39	39	46	46
1265	32×32mm	31	31	38	38

PLCC SERIES

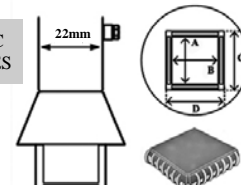

MODEL #	IC SIZE	A (mm)	B (mm)	C (mm)	D (mm)
1135	17.5×17.5mm	17.5	17.5	24.5	24.5
1136	20×20mm	20	20	27	27
1137	25×25mm	25	25	32	32
1138	30×30mm	30	30	37	37
1139	7.3×12.5mm	7.5	12.5	14.5	19.5
1140	11.5×11.5mm	12	12	19	19
1141	11.5×14mm	12	14	19	21
1188	9×9mm	10	10	17	17
1189	34×34mm	35.5	35.5	42.5	42.5

SOP SERIES

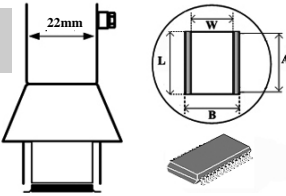

MODEL #	IC SIZE	L (mm)	W (mm)	A (mm)	B (mm)
1131	4.4×10mm	11	3.8	9	10.3
1132	5.6×13mm	16	4.7	14	11.7
1133	7.5×15mm	17	6	15	13
1134	7.5×18mm	20	6	18	13
1257	11×21mm	22	11	20	18
1258	7.6×12.7mm	12	7	10	14
1259	13×28mm	30	12.5	28	19.5
1260	8.6×18mm	20	7.7	18	14.7

SOJ SERIES

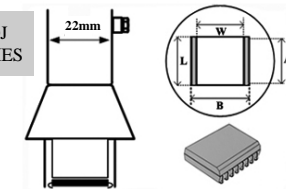

MODEL #	IC SIZE	L (mm)	W (mm)	A (mm)	B (mm)
1183	15×8mm	17	7	15	14
1184	18×8mm	20	9	18	16
1214	10×26mm	27	11	25	18

TSOL SERIES

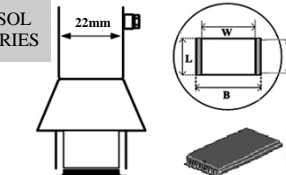

MODEL #	IC SIZE	L (mm)	W (mm)	A (mm)	B (mm)
1185	13×10mm	11	11	9	18
1186	18×10mm	12	17	10	24
1187	18.5×8mm	11	18	9	25

BQFP SERIE

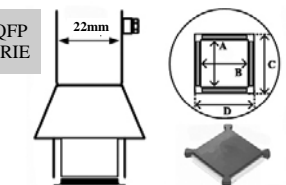

MODEL #	IC SIZE	L (mm)	W (mm)	A (mm)	B (mm)
1180	17×17mm	17.2	17.2	24.2	24.2
1181	19×19mm	18.2	18.2	25.2	25.2
1182	24×24mm	23.2	23.2	30.2	30.2
1203	35×35mm	34.2	34.2	41.2	41.2

AOYUE[®] Int850

SMD REWORK STATION

INSTRUCTION MANUAL

Thank you for purchasing 850 SMD Rework Station.
Please read the manual before using the unit.
Keep manual in accessible place for future reference.

WARNING: When turned ON, temperature of the hot air gun ranges from 100°C - 500°C. Injury might occur if not handled properly.

** This product is ESD-protected.
** Specifications and design are subject to change without prior notice.

This appliance can be used by children aged from 8 years and above and persons with reduced physical, sensory or mental capabilities or lack of experience and knowledge if they have been given supervision or instruction concerning use of the appliance in a safe way and understand the hazards involved. Children shall not play with the appliance. Cleaning and user maintenance shall not be made by children without supervision.

The specific instructions related to the safe operation of this appliance (as given in 7.12 of this standard) shall be collated together in the front section of the user instructions. The height of the characters, measured on the capital letters, shall be at least 3 mm. These instructions shall also available in an alternative format, e.g. on a website.

A fire may result if the appliance is not used with care, therefore:

- be careful when using the appliance in places where there are combustible materials ;
- do not apply to the same place for a long time;
- do not use in presence of an explosive atmosphere;
- be aware that heat may be conducted to combustible materials that are out of sight;
- place the appliance on its stand after use and allow it to cool down before storage;
- do not leave the appliance unattended when it is switched on.

Rohs

Correct Disposal of this product	
	This marking indicates that this product should not be disposed with other household wastes throughout the EU. To prevent possible harm to the environment or human health from uncontrolled waste disposal, recycle it responsibly to promote the sustainable reuse of material resources. To return your used device, please use the return and collection systems or contact the retailer where the product was purchased. They can take this product for environmental safe recycling.

Manufacturer:
AOYUE INTERNATIONAL LIMITED
Jishui Industrial Zone, Nantou, Zhongshan City,
Guangdong Province, P.R.China
<http://www.aoyue.com>

REPLACING THE HEATING ELEMENT

1. Remove the screws (see fig.4) then slide off the tube.
2. Disconnect the ground wire sleeve (see fig. 5-1) and remove the pipe. Inside the pipe, the Quartz glass and heat insulation is installed.
3. Disconnect the terminal (see fig. 5-2) and remove heating element.
4. Carefully insert new heating element and reconnect the terminal. Avoid touching the heating element wire.
5. Reconnect the ground wire after replacing the element then reassemble unit.

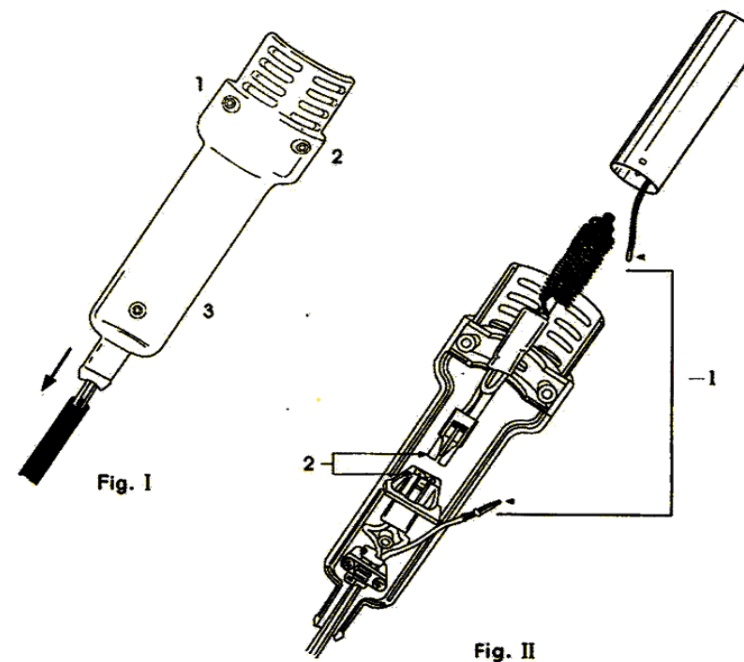

OPERATING INSTRUCTIONS

Desoldering

1. Plug in – this starts the blowing function but heating element remains cool.
2. Turn on –this begins the heating up of the heating element.
3. Set temperature and air flow - we recommend you to adjust temperature initially at around 300-350°C and an air flow of 1-3.
4. Place IC Popper under IC lead (see fig. 3).
5. Melt solder - be careful not to touch the leads of the IC with the nozzle.
6. Remove the IC.
7. Turn off the power switch.



Fig. 1

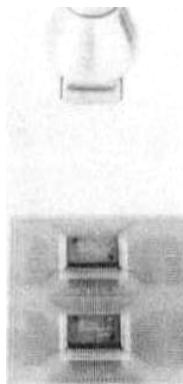

Fig. 2

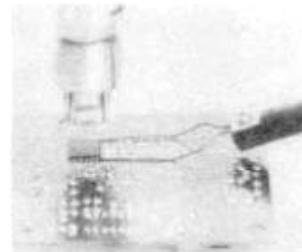

Fig. 3

TABLE OF CONTENTS

Package Inclusion	3
Specifications	3
Parts List	4
Care and Safety Precaution	4
Function	5
Operating Instruction	
Soldering	5
Desoldering	6
Replacing the heating element	7

PACKAGE INCLUSION

850 Station with hot air gun	1
Air nozzles (1124, 1130, 1197)	3
G001 IC popper	1
Z001 Hot air gun holder	1

SPECIFICATION

Power Input :	available in 110V / 220V
Power Consumption:	250W - 300W
Temperature Range:	100°C - 500°C
Heating Element:	Metal Heating Core
Pump/Motor Type:	Diaphragm Pump
Air Capacity:	23 l /min (max)
Station Dimensions:	188(w) x 127(h) x 244(d) mm
Weight:	3.7Kg

PARTS LIST

Part No.	Description
20093	Heating Element
30104S	Hot Air Gun Plastic Handle
S001	Hot Air Gun Complete Handle
20932	Hot Air Gun Metal Pipe
P001	Diaphragm Pump

CARE and SAFETY PRECAUTIONS



CAUTION: Misuse may cause injury and physical damage.
For your own safety, be sure to comply with the following precaution.

- Temperature may reach a high of 500°C when turned on.
 - Do not use near flammable gases, paper and other materials.
 - Do not touch heated parts, can cause severe burns.
 - Warn people around work area.
- Thermal Protector
 - If the thermal protector trips, reduce the temperature setting or increase the air flow to decrease temperature to safe level.
 - Unit is equipped with auto shut-off ability when temperature gets too high and automatically turns on when temperature dropped to a safe level.
- Auto-Cooling Function
 - Unit is designed to blow cool air after being turned off. Do not unplug station during this cooling process.
- Handle with Care
 - Never drop or sharply jolt the unit.
 - Contains delicate parts that may break if unit is dropped.
- Disconnect plug when not to be used for a long period of time.
 - Turn off power during breaks.
- Use only genuine replacement parts.
 - Turn-off power and let unit cool before replacing parts.
- Do not modify unit

FUNCTION

- Electrostatic discharge safe design with grounding measures.
- Voltage pulse signal controlled hot air temperature.
- Hot air temperature and air pressure are both adjustable by traditional knob type controls to suit different users needs.
- With added safety feature. It automatically blows cool air after use thus prolonging the usage life of the heating system.
- Compatible with various types of air nozzles to perform various types of tasks. Please refer to page 8 of this manual for a list of available nozzles.

OPERATING INSTRUCTIONS

Soldering

1. Plug in – this starts the blowing function but heating element remains cool.
2. Turn on –this begins warming up the heating element.
3. Set temperature and air flow -- we recommend you to adjust temp. around 300-350°C and air flow of 1-3.
4. Apply the solder paste.
5. Preheat SMD (see fig.1 on page 6).
6. Soldering – heat the lead frame evenly (see fig. 2 on page 6).
7. Wash away excess flux.